

catálogo para profesionales

# catálogo para profesionales



*Materiales  
y Complementos  
para el Viverismo  
y la Jardinería*

2015  
2016



**TOLTEX**

SERRALUNGA  
1825

**ICL** Specialty  
Fertilizers

**FELCO**



**MANKAR**

**GRIPPLE**

THERMODISC

**plantSCAPE**  
perfect plants in public places

**BELLOTA**



**wanzi**

SUPERROOTS  
**AIR-POT**



**mendi**



visítenos en: [www.myc-5.com](http://www.myc-5.com)

[www.myc-5.com](http://www.myc-5.com)



MOBILIARIO Y ACCESORIOS GARDEN



## Cestas GT26 eco

Código	Descripción	Capacidad
W-025582307	<b>Cesta Plástico GT26</b> - 100% reciclado - Se adapta al Carro Gardener 100 - Apilables - Cesta negra con asa de colores - Capacidad de carga 7 kg.	26 litros

**wanzl**



## Cestas WANZL

Código	Descripción	Capacidad
W-CESTAS	<b>Cesta Plástico COLORES</b> Con asa plegable.	30 l.
W-020389810	<b>Cesta HW 16 Cromada</b>	16 l.



## Cestos Garden Orlandelli

Código	Descripción	Capacidad
OR-27212502	Cesto <b>Metálico</b> para garden 46 x 34 x 20	25 litros
OR-27222500	Cesto <b>Plástico</b> con asa Metálica 48 x 33 x 27,5	



## Pinza para Cactus

Código	Descripción
OR-36040118	Pinzas para cactus





## Carrys

Código	Descripción
OR-28010001	<b>Base para carry</b>
OR-28012001	<b>Base para carry RUEDA GRANDE 20 x 5 cm</b> Bajo pedido
OR-28030002	<b>Columnas</b> para carry standard.
OR-28020001	<b>Bandeja</b> de carry-estratíf marino 5 mm
OR-28040001	<b>Prolongación</b> para carry 35 cm.

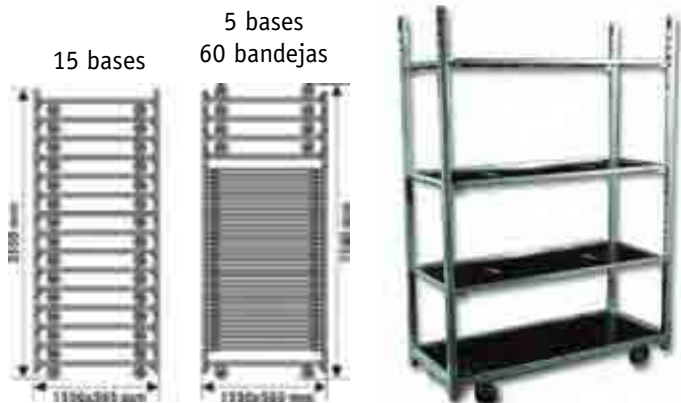

BASE RUEDA GRANDE  
BAJO PEDIDO



## Bandejas DANESA ABS

Bandeja Unistandard depósito agua

Disponible en colores: Negro Verde Rojo Amarillo Blanco



Código	Descripción	Fabricante	Color
OR-29080003	Bandeja 126,5 x 55 x 4,5	Orlandelli	Blanco
OR-29080004	Bandeja 126,5 x 55 x 4,5	Orlandelli	Negro
OR-29080005	Bandeja 126,5 x 55 x 4,5	Orlandelli	Rojo
OR-29080006	Bandeja 126,5 x 55 x 4,5	Orlandelli	Amarillo
OR-29080007	Bandeja 126,5 x 55 x 4,5	Orlandelli	Verde



DANESA

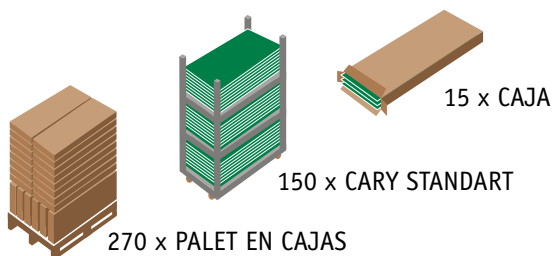

## Bandejas CLÁSICA ABS

Bandeja Unistandard depósito agua

Código	Descripción	Fabricante	Color	Peso
BAND-ABSV	127 x 56 x 4,5	Erba	Verde	1,5 Kg.



CLÁSICA

## Bandejas LIGHT PVC

Bandeja Unistandard depósito agua

Código	Descripción	Fabricante	Color	x Caja	Peso
BAND-PVC	127x 56 x 2,5	Erba	Negro	20	0,4 Kg.



LIGHT





## Carro Garden WANZL

Código	Descripción
W-056261051	<b>Carro Garden Bricol.T-24</b>
W-019401207	<b>Monedero</b> para carro garden Solid WBOX

## Parking para Carros

Código	Descripción
W-237034455	U Inicial para <b>2 filas - sin panel</b> informativo
W-237099855	U Inicial para <b>2 filas - con panel</b> informativo
W-237034655	U Inicial para <b>3 filas - sin panel</b> informativo
W-237814055	U Inicial para <b>3 filas - con panel</b> informativo
W-234554055	<b>Lateral 1,5 m.</b> (precio por unidad)
W-236860355	<b>Lateral 3 m.</b> (precio por unidad)
W-017815107	<b>Panel informativo</b> w box
W-233898155	<b>Marco</b> panel instrucciones ext.W box
W-016970309	<b>Llave inicio 1 m.</b> Sin fijación

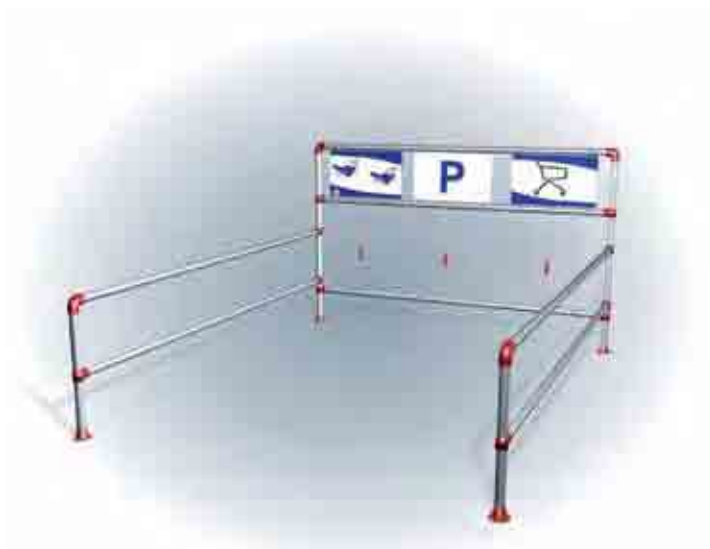

## Carro Garden Flor 3 Rellanos

Código	Descripción
OR-27151802	<b>Carro Garden Flor 3 rellanos</b> Emcajable, mayor capacidad. Ruedas de poliuretano de 12,5 cm. largo 1.120 x ancho 560 x alto 1.115 mm. Con gancho para moneda

OR-36900040 **Monedero**



## Carretilla tipo Paleta

Código	Descripción	Capacidad
CARR-PAPLA	Carretilla tipo paleta <b>plástico</b> Color Verde	110 litros



## Carretilla tipo Paleta

Código	Descripción	Capacidad
CARR-PAMET	Carretilla tipo paleta <b>metálica</b>	60 litros



## Carretilla Garden Center

Código	Descripción	Kg. soporta
CARR-G1002	<b>Carretilla Garden Center Con Ruedas Compactas</b> Base de 55 x 70 x 20 cm	50



**RUEDAS  
COMPACTAS**

## Carro ORO Galvanizado

Código	Descripción
OR-27300002	<b>Carro ORO galvanizado</b> rejilla Capacidad de la cesta 85 x 65 x 18,5 cm Medidas tot. 70 cm. alt. x 65 anc. x 145 lar.



Consulte la opción de  
**RUEDAS COMPACTAS**





## Carritos Expositores (Carry extensible)

Código	Descripción
OR-33340160	Carry extensible. Altura 160 cm. <b>SIN TOLDO</b> 4 RELLANOS + 4 bandejas de colores



+



=



GUÍAS LATERALES

## Complementos Carritos Expositores

Código	Descripción
OR-36005417	<b>Toldo</b> y soporte para carry <b>extensible</b> PVC Colores blanco con Rojo / Verde / Amarillo
OR-33300160	<b>Guías laterales</b> carry extensible - 160 cm



TOLDOS



## Carritos Expositores Rueda Grande

Código	Descripción
OR-34020028	Carrito expositor <b>Blanco con 2 bandejas</b> Con toldo Blanco/Verde 140 x 78 x 205
OR-34020051	Carrito expositor <b>Blanco con 16 cubetas</b> galvanizadas Con toldo Blanco/Verde 140 x 78 x 205
OR-34020037	Carrito expositor <b>Blanco con 8 cubetas y 1 bandeja</b> Con toldo Blanco/Verde 140 x 78 x 205



## Soporte Altura Regulable de 50 a 90 cm.

Código	Descripción
OR-29099430	Soporte altura regulable con ruedas <b>SIN BANDEJA</b> Largo 127 x Ancho 58 x Alto 50/90 cm.
OR-29099432	Soporte altura regulable con ruedas <b>CON BANDEJA</b> Largo 127 x Ancho 58 x Alto 50/90 cm.



## Expositores Plegables

Código	Descripción
OR-34010302	Expositor de hierro - <b>3 RELLANOS</b> - 170 x 95 x 90
OR-34010402	Expositor de hierro - <b>4 RELLANOS</b> - 170 x 135 x 105
OR-29096017	<b>Bandeja verde</b> para expositor plegable 170 x 44 x 5





## Expositores de Pared - Aluminio

Para Bandeja Danesa ABS

Código	Descripción
OR-33131001	Expositor aluminio <b>1 bandeja</b> por rellano 3 rellanos (superior extraible) + 3 bandejas 127 x 113 x 138/168
OR-33132001	Expositor aluminio <b>2 bandejas</b> por rellano 3 rellanos (superior extraible) + 6 bandejas 254 x 113 x 138/168



1 X RELANO  
3 RELANOS



2 X RELANO  
3 RELANOS



## Expositores Doble Cara - Aluminio

Para Bandeja Danesa ABS

Código	Descripción
OR-33151001	Expositor aluminio <b>1 bandeja por rellano</b> 5 rellanos (superior extraible) + 5 bandejas 127 x 167 x 138/168
OR-33152001	Expositor aluminio <b>2 bandejas por rellano</b> 5 rellanos (superior extraible) + 10 bandejas 254 x 167 x 138/168



1 X RELANO  
5 RELANOS



2 X RELANO  
5 RELANOS





## Expositor de Aluminio 3 Rellanos

Con ruedas

Modelo	Descripción
OR-508508502525	4 Ruedas Giratorias $\varnothing$ 10 cm (2 autoblocantes) Reserva de agua de Polystyreno hermética. Largo 2.525 x Ancho 850 x Alto 1.500 mm.
OR-508508503025	4 Ruedas Giratorias $\varnothing$ 10 cm (2 autoblocantes) Reserva de agua de Polystyreno hermética. Largo 3.025 x Ancho 850 x Alto 1.500 mm.

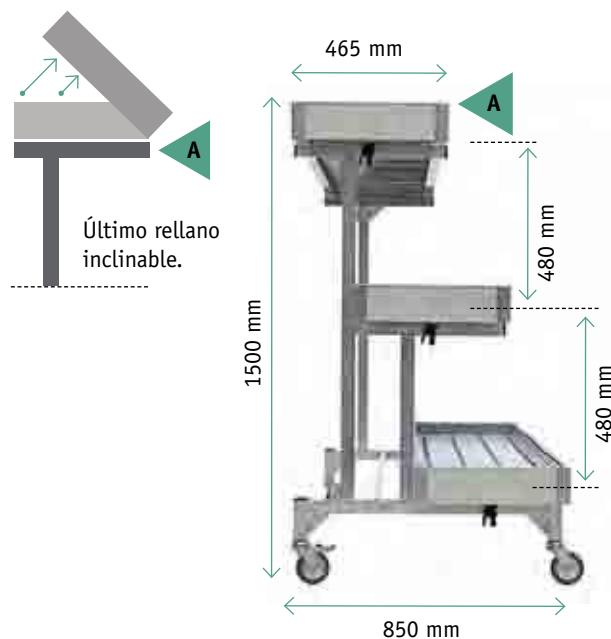

## Expositor Isla de Aluminio 3 Rellanos

Con ruedas

Modelo	Descripción
OR-503513802065	4 Ruedas Giratorias $\varnothing$ 10 cm (2 autoblocantes) Reserva de agua de Polystyreno hermética. Con desagüe. Estructura de aleación de aluminio.



Rellano N° 2  
2055 x 465

Rellano N° 1  
2066 x 825





## Mesas de Exagonales

Código	Descripción
50700000S03E	<b>SET de 3 Mesas</b> hexagonales Aluminio + manta riego 3 alturas fijas: 35cm + 55cm + 75cm
50700000S05E	<b>SET de 5 Mesas</b> hexagonales Aluminio + manta riego 3 alturas fijas: 35cm + (3)55cm + 75cm
50700565P650	<b>Mesa 2 alturas</b> Aluminio + manta riego Alza: 56,5 x 65 palo 60Ø altura 55cm + manta riego

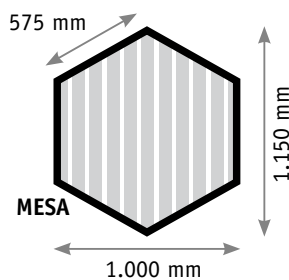

### Mesas de Exagonales

- Altura fija de 35, 55 o 75 cm
- Material: aluminio
- Bandeja ABS
- Grifo de descarga
- Manta de riego

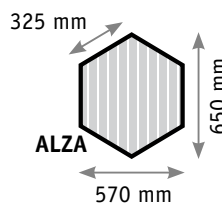

### Alzas

- Altura fija de 55 cm
- Material: Aluminio
- Bandeja ABS
- Grifo de descarga
- Manta de riego



SET de 3 Mesas



SET de 5 Mesas



Mesa 2 alturas



## DISPLAY PORTA CARTELES

Barnizado Color Verde RAL-6012

Código	Descripción	Cartel
OR-54PGR005V012	Para mesa rectangular 1,025 m	Largo 945 mm
OR-54PGR006V012	Para mesa rectangular 2,055 m	Largo 1.975 mm
OR-54PGR007V012	Para mesa rectangular 1,225 m	Largo 1.145 mm
OR-54PGR008V012	Para mesa rectangular 2,530 m	Largo 2.450 mm
OR-54PGR004V012	Para mesa hexagonal 1 x1,15 m	Largo 500 mm
OR-54GPROA4V012	Display A4 apaisado	Largo 297 mm



21 cm DIN A4  
15 cm DIN A5



## Mesas de Aluminio Rectangulares

- Altura regulable (55-75 cm.)
- Con ruedas (10 cm. ø) 2 autoblocantes 2 giratorias
- Mínimo 3 unidades.
- Sin ruedas - Altura fija 75 cm bajo pedido

### Medidas Standard.

- 1.025 x 2.055
- 1.225 x 2.530
- 1.025 x 2.530

### Otras Medidas.

- 1.625 x 3.030
- 1.625 x 3.530

### ALTURA REGULABLE

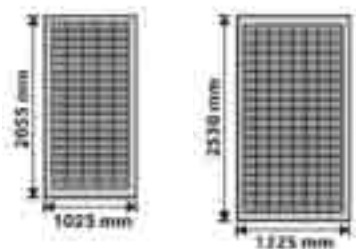

## Mesas de Aluminio Rectangulares Low Cost

- Altura fija (35 cm - 55 cm - 75 cm)
- Sin ruedas.
- En palets de 10 ó 20 unidades - desmontadas

Medidas Standard.	x palet	alt. 35	alt. 55	alt. 75
1.025 x 2.055 mm.	10 unid.	2	2	6
	20 unid.	4	4	12
1.225 x 2.530 mm.	10 unid.	2	2	6
	20 unid.	4	4	12
1.625 x 3.030 mm.	10 unid.	-	-	10
	20 unid.	-	-	20
1.625 x 3.530 mm.	10 unid.	-	-	10
	20 unid.	-	-	20



Kits automontage de 10 y 20 unidades



También se pueden servir todas de la misma altura.

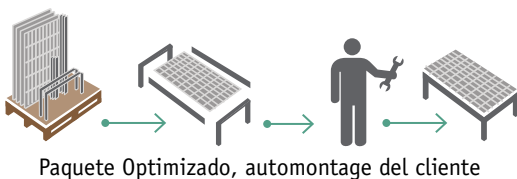



## Mesas de Aluminio



Sistema de mesa móvil con subestructura BS (metal) o tubos metálicos para fijar en el suelo.  
Mesas para puntos de venta o producción.

*Llámenos para pedir presupuesto y especificaciones técnicas.*







## Condiciones de venta

- 1.- En el primer pedido el cliente deberá abonar la totalidad de la factura al contado.
- 2.- No se atenderán reclamaciones efectuadas después de los tres días de recepción de la mercancía.
- 3.- Todo litigio será resuelto en los tribunales de esta plaza renunciando el comprador al fuero de su domicilio.
- 4.- El precio de la mercancía se verá incrementado con el IVA correspondiente.

# situación

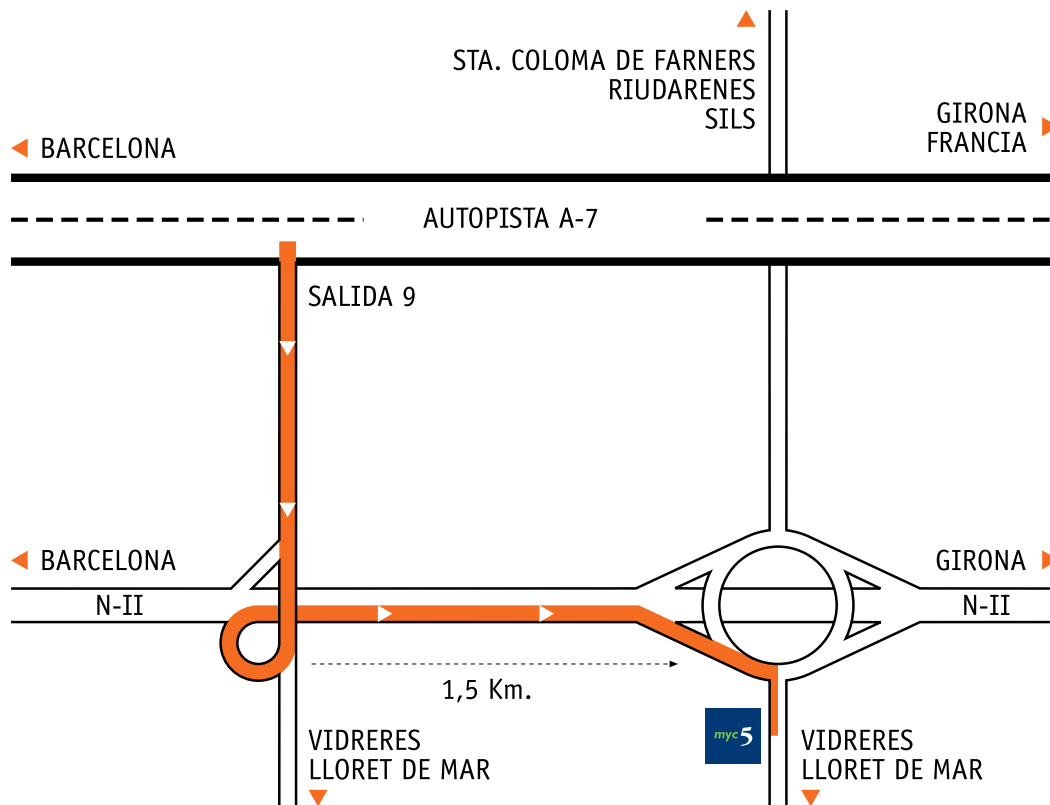

**Material  
y Complementos  
para el Viverismo  
y la Jardinería**

Cruce N-II / Ctra. Vidreres  
Apartado de Correos 26  
17410 SILS (Girona) SPAIN  
Tel 972 87 51 97  
Fax 972 85 04 82  
[www.myc-5.com](http://www.myc-5.com)  
[info@myc-5.com](mailto:info@myc-5.com)

Coordenadas GPS  
LATITUD: 41 ° 48' 11,82" N  
LONGITUD: 2° 45' 58,78" E